

THE PROPERTY OF THE DRAWING IS ESTABLISHED BY LAW. IT IS FORBIDDEN TO PRODUCE OR SHOW IT TO THIRD PART. WITHOUT A WRITTEN AGREEMENT.

Item	Name	Q.ty
1	CA.08.03.002	1
2	CA.08.09.006	1

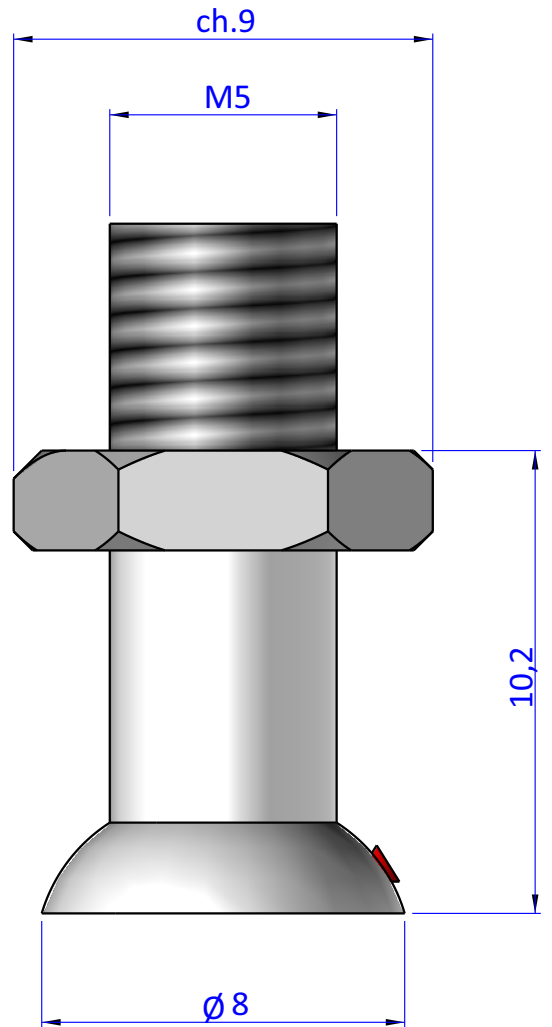
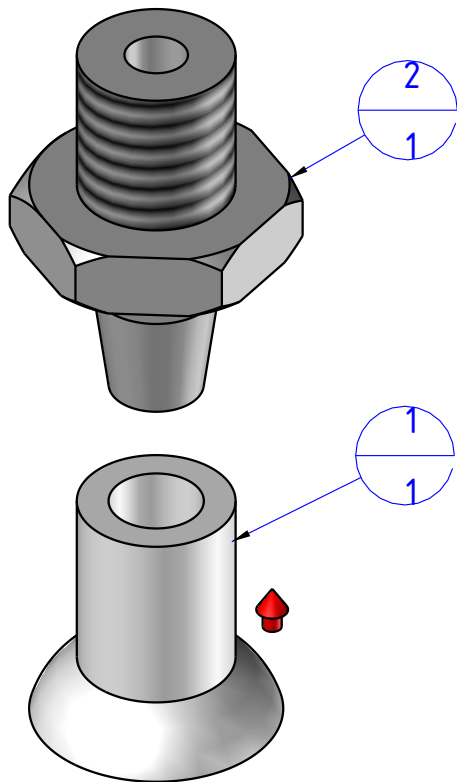

DESIGNED FROM FPS Automation		REVIEW A
DATE 03/11/2020	WEIGHT 0,001kg	
CODE KIT.08.03.D08.6		

Format **A4**
UNI 936-76

GENERAL TOLERANCE
UNI - ISO 2768
CLASSE **f**

DESCRIPTION
KIT.08.03.D08.6